

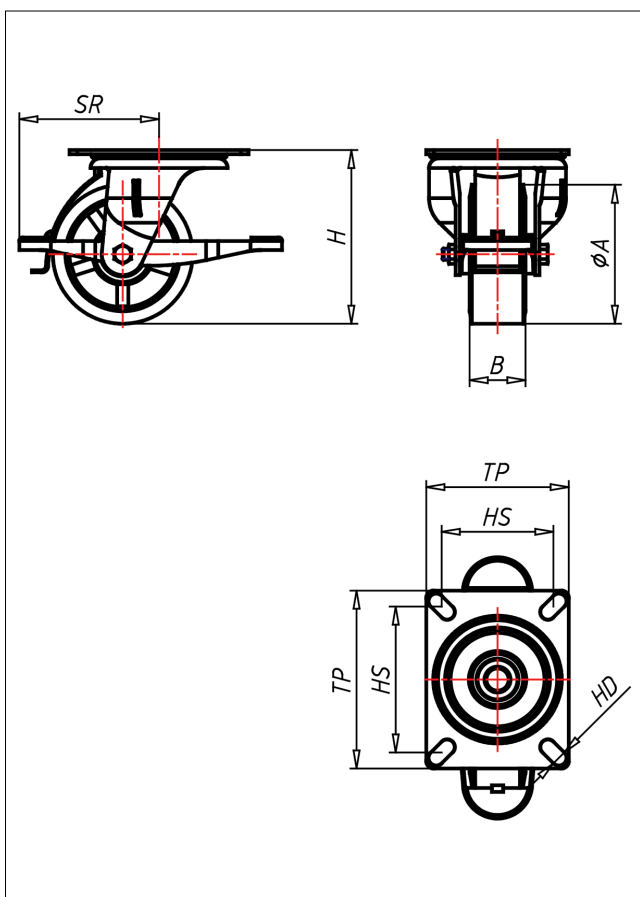

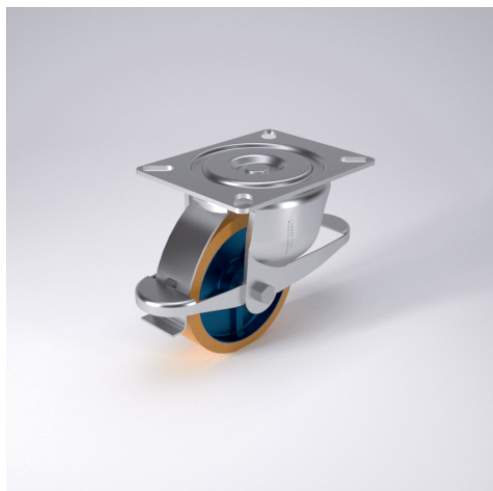



61BR-ZK/SUB

Lenkrolle mit Radfeststeller

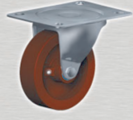

61-SU



LENKROLLE	LENKROLLE MIT RADFESTSTELLER	BOCKROLLE																		
 <ul style="list-style-type: none"> • geräuscharmer Lauf • geringer Rollwiderstand • abrieb- und reißfest • hohe Stoßfestigkeit • sehr beständig gegen viele aggressive Medien <p>Guss-Polyurethan Felge Gusseisen lackiert → Seite 247</p> 	 <p>sehr großes Schwenklager - lange Lebensdauer, Gabelschenkel speziell geformt, Radachse verschraubt - gesichert, verzinkt → Seite 42</p> 	 <p>AUSWAHLHILFE:</p> <table border="0"> <tr> <td>-</td> <td>+</td> <td>++</td> </tr> <tr> <td>leicht lenkend</td> <td>X</td> <td>X</td> </tr> <tr> <td>verschleißarm</td> <td>○</td> <td>X</td> </tr> <tr> <td>stoßfest</td> <td>○</td> <td>X</td> </tr> <tr> <td>bodenschonend</td> <td>○</td> <td>X</td> </tr> <tr> <td>witterungsbeständig</td> <td>X</td> <td>○</td> </tr> </table>	-	+	++	leicht lenkend	X	X	verschleißarm	○	X	stoßfest	○	X	bodenschonend	○	X	witterungsbeständig	X	○
-	+	++																		
leicht lenkend	X	X																		
verschleißarm	○	X																		
stoßfest	○	X																		
bodenschonend	○	X																		
witterungsbeständig	X	○																		

Technische Details

ORDERNO (Artikel-nummer)	61BR-100 ZK
WDAB (Rad-Ø A x Breite B / mm)	100x30
LC (Tragkraft / kg)	250
H (Bauhöhe H / mm)	125
TP (Plattengröße / mm)	128x102
HS (Lochabstand / mm)	105x80
HD (Loch-Ø / mm)	11
SR (Schwenkradius / mm)	100
WB (Radlager)	Kugellager